

LawnMaster®

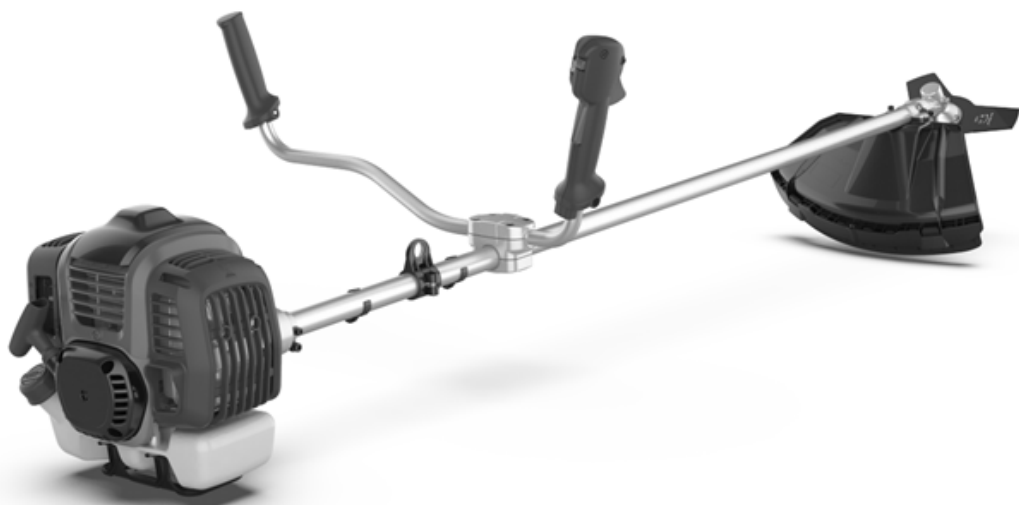

45CC **BRUSH CUTTER**

SAFETY AND OPERATING MANUAL

PLEASE READ THIS MANUAL CAREFULLY BEFORE OPERATING THE UNIT

BC451



A STEELFORT PRODUCT



PROUDLY
NZ OWNED



TABLE OF CONTENTS

OPERATOR SAFETY	3
GETTING STARTED	5
Assembly	
FEATURES & TECHNICAL DATA	9
OPERATION	10
Fuel & Oil Mixture	
Rules for Operation	
Preparing for Operation	
STARTING THE BRUSH CUTTER	11
Starting the Engine	
Fitting the Belt	
Cutting with the Brush Cutter	
Extending the Cutting Line	
Stopping the Engine	
MAINTENANCE & STORAGE	14
Maintenance Schedule	
Air Filter	
Spark Plug	
Cleaning	
Angle Transmission	
Storage	
TROUBLESHOOTING	18
WARRANTY	19

Thank you for purchasing our LawnMaster BC451 Brushcutter, the information contained within this manual will help you to have many years of safe and trouble free use of this Lawnmaster product.

OPERATOR SAFETY

SAFETY RULES

This manual contains important safety information and instructions to operate the LawnMaster Brush Cutter.

PLEASE READ THIS MANUAL CAREFULLY BEFORE USING THE UNIT.

Failure to adhere to the safety instructions could result in property damage and/or serious personal injury.

This manual should be considered a permanent part of the brush cutter and should remain with the unit at all times. All information in this publication is based on the latest product information available at the time of printing.

Product Information and specifications can be altered and/or improved without notice. Content from this publication may not be reproduced without written consent.

DANGER

Indicates a hazardous situation which, if not strictly complied with, will result in substantial property damage and or serious injury.

WARNING

Indicates a hazardous situation which, if not strictly complied with, may result in property damage

CAUTION

Indicates a hazardous situation which, if not strictly complied with, could result in property damage or personal injury.

The warnings and precautions discussed in this manual does not cover all possible conditions and or scenarios that may occur.

It must be understood by the operator that common sense and caution must be taken into consideration when operating this product, as these are factors which cannot be built into this manual.

DANGER

TOXIC FUMES

- The exhaust of the engine contains carbon monoxide, an odorless, colorless poison gas. Using the engine in confined/indoor spaces can be extremely dangerous and life threatening.

FIRE

- When operating the unit, the engine may create sparks that could trigger fires.
- When operating around dry vegetation such as agricultural crops, forest, bush, grass, or other similar environments please be careful.
- This engine may not be equipped with a spark arresting muffler. In some countries and regions, a spark arrester is required by law. Please contact your local council and or fire agency for laws and regulations relating to fire prevention requirements.
- Petrol is highly flammable and explosive. A fire and or explosion from petrol can cause severe burns or result in serious personal injury including death.
- Keep flammable items away while handling petrol. Fill fuel tank outdoors and in a well ventilated area with the engine stopped.
- Always wipe spilled fuel and wait until the fuel has dried before starting the engine.
- DO NOT operate the engine with known leaks in the fuel system. Use proper fuel storage and handling procedures.
- Empty the fuel tank before storing or transporting the brush cutter.
- Keep fire extinguisher handy at all times.

HOT SURFACE

- Running the brush cutter will produce heat and severe burns may occur upon contact. DO NOT touch the engine while under operation or just after stopping the unit.
- Avoid contact with hot exhaust gases and or hot surfaces.
- Maintain at least 1m of clearance on all sides to ensure adequate cooling. Combustible material can catch fire upon contact. Maintain at least 3m of clearance from combustible materials.

GENERAL WARNINGS

- Before use, check for loose or damaged parts, signs of oil or fuel leaks, and any other condition that may impact operation.

- Repair or replace all damaged and or defective parts immediately.
- Locate all operating controls and safety labels.
- Make sure all the safety instructions are in correct working condition.
- Keep all safety guards in place and in proper working order at all times.
- DO NOT allow any material to block the cooling slots.
- DO NOT allow children or untrained people to operate the unit.
- Read the instructions carefully. Be familiar with the controls and the proper use of the appliance.
- This product has been designed for use in cutting grass, and it should never be used for any other purpose.
- Never use while people, especially children, or pets are nearby.
- The operator or user is responsible for accidents or hazards occurring to other people or their property.
- Always store fuel in a properly marked container that complies with New Zealand standards.
- Do not mix fuel in an enclosed room or near an open flame, ensure adequate ventilation.
- Never attempt to make engine adjustments while the engine is running and strapped to the operator.

PREPARATION

- Petrol is highly flammable: Store fuel in containers specifically designed for this purpose; refuel outdoors only and do not smoke while refueling; add fuel before starting the engine. Never remove the cap of fuel tank or add petrol while the engine is running or when the engine is hot; if petrol is spilled, do not attempt to start the engine but move the machine away from the area of spillage and avoid creating any source of ignition until petrol vapors have dissipated. Replace all fuel tank and container caps securely.
- Replace faulty silencer.
- Before using, always visually inspect to see that the tools are not worn or damaged. Replace worn or damaged elements and bolts in sets to preserve balance.
- Never put any items into the ventilation openings. Non-observance may lead to injury, or damage to the machine.

- It is necessary reduction in power due to use in higher temperatures, altitudes and humidity as below conditions.

Max Working Temperature: 40°C

Max Altitude: 1000 m

Max Humidity: 95%

OPERATION

- Do not operate the engine in a confined space where dangerous carbon monoxide fumes can collect.
- Keep the machine free of oil, dirt and other impurities.
- Always place the appliance on even and stable surfaces.
- Never operate the appliance inside buildings or in an environment without proper ventilation.
- Do not operate or store the appliance in wet or humid surroundings.
- Ensure the sound absorber and air filter work properly.
- Do not touch the exhaust system or other parts that become hot during operation.
- The engine must not be operated with excessive rotary speed. The operation of the engine with excessive rotary speed raises the risk of injury.
- Regularly check for leakage or traces of abrasion in the fuel system, such as porous pipes, loose or missing clamps and damage to the tank or tank cap.
- Work only in daylight or in good artificial light.
- Never pick up or carry a machine while the engine is running.
- Stop the engine whenever you leave the machine and before refueling.
- Before checking or adjusting the machine, the ignition plug and the ignition wire respectively must be removed to prevent accidental starting.
- Do not use the machine when the operator is tired, ill or under the influence of alcohol or the drugs.
- Wear safety goggles and ear protection.
- Ensure that you maintain a steady foothold.
- Only use the brush cutter on flat surfaces where you have a firm footing.
- Always wear substantial footwear and long trousers. Do not operate the equipment when barefoot or wearing open sandals.

- Always hold the brush cutter with two hands
- Always use the harness when operating, adjust the length of the harness to ensure it is suitable for operation.
- Always use the correct blade and spool recommended by the manufacturer.
- Always ensure that the ventilation openings are kept clear of debris.
- Perform inspection before use and after any fall or other impact to identify significant defects.
- Rest frequently and change working positions. Keep balance position during operation, use the harness.

WARNING

It has been reported that, for some people, the vibrations produced by the motorized hand tools can lead to develop a disease called Raynaud's syndrome or white finger. Symptoms may include tingling, numbness and blanching of the fingers, usually caused by exposure to cold. There is currently no evidence that a certain type of vibration or exposure actually contributes to the development of this assignment. Some measures that can reduce the effects of vibration, can be taken by the operator:

- Keep your body warm in cold weather. During use, wear gloves to keep your hands and wrists warm. It has been reported that cold weather is one of the main causes of Raynaud's Syndrome.
- After each period of operation, exercise to increase circulation.
- Take frequent breaks. Limit the duration of daily exposure.
- Keep the tool well maintained, all fasteners tightened and worn parts replaced.
- In case of occurrence of one or more of the symptoms described above, stop using the tool and seek medical attention.

GETTING STARTED

The brush cutter is a high-speed and fast cutting power tool. All safety precaution must be observed to reduce the risk of personal injury. Please read this manual carefully and become familiar with the controls before using the unit.

ASSEMBLY

When assembling this machine, please follow the instructions for assembly printed.

INSTALL THE MAIN BODY

Connect the engine (A) to the tube (B) with four screws (C).

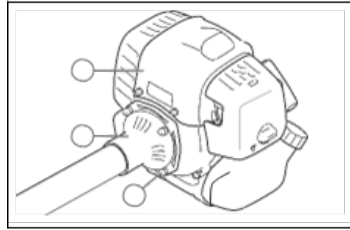

ASSEMBLY OF THE HANDLE

(FIG.1-1,2,1-3)



FIG.1-1



FIG.1-2

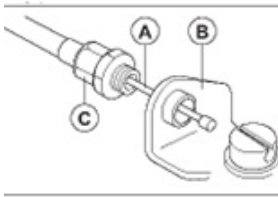

FIG.1-3

1. Remove the screws infixing device and remove the upper cover. (Fig.1-1)
2. Place the handle in position and assemble the upper cover. (Fig.1-2)
3. Assemble and tighten the screw. (Fig.1-3)

CONNECT THE THROTTLE CABLE AND STOP SWITCH WIRES

1. Remove the air filter cover
2. Install the throttle cable (A) through the carburettor bracket (B)



3. Turn the cable adjuster sleeve (C) into the carburettor bracket fully
4. Put the slot fitting (D) on the carburettor. At this time the recessed hole (E) throttle cable plug (F) is away from the cable adjuster sleeve (C)

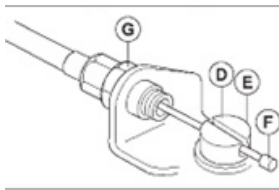

5. Rotate the carburettor throttle cam and move the throttle cable (A) through the slot in the slot fitting.
6. Make sure the cable lug (F) drops into the recessed hole.
7. Operate the throttle trigger some times to make sure that it operates correctly.
8. Adjust the cable adjuster sleeve (C).
9. Make sure the stop on the carburettor throttle cam touches the throttle stop correctly.
10. Make sure the cable position keeps 1-2 mm between cable lug (F) and slot fitting when the throttle trigger is fully pushed.

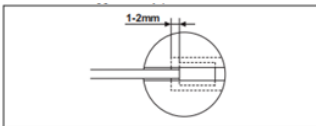

11. When the throttle cable (A) is adjusted correctly, tighten the lock nut (G).
12. Connect the stop switch wires (H) with the connectors from the engine.

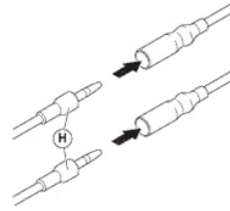

13. Install the air filter cover.

WARNING

Do not tighten the screws until you have set the handle in optimal working position. Please always adjust the handle position with full assembled accessories. The black cable tie can be used to fix the throttle cable to the metal tube. (Fig.2)



ASSEMBLE THE GUARD

(FIG.3-1, FIG.3-2)

1. Place the guard on the fixture. (Fig3-1)
2. Assemble and tighten the screws. (Fig.3-2)

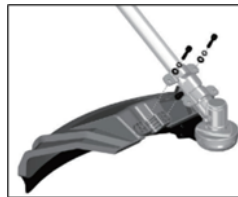

FIG.3-1

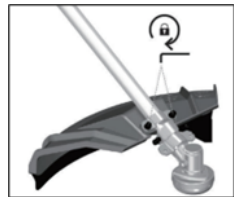

FIG.3-2

WARNING

When using the cutting line head, the additional guard, with line cutting knife, must always be fitted. (Fig.3-3, Fig.3-4)

Secure the additional guard (26) using the screw (B). (Fig.3-3)



FIG.3-3

TAKE OFF ADDITIONAL GUARD

1. Screw off the screw (B); (Fig. 3-3)
2. Push the clip (C), and pull out the additional guard. (Fig.3-4)



FIG.3-4

WARNING

Please check the blade and output shaft after each adjustment or assembly, it must be correctly assembled and running smoothly. Wear protective gloves when handling the guard.

FITTING THE 3T BLADE

(FIG. 4)

Take the outer flange off after release the nut, then put the blade, outer flange, shield and nut according to priority as below picture. Note the blade rotation direction needs be same as below picture. Use screw driver to hold flange and tighten nut counter-clockwise, ensure the nut is tightened enough.



FIG.4-1

RELEASE THE BLADE

(FIG 5)

Use screw driver to hold flange and release nut, the blade can be took off.



FIG.5-1

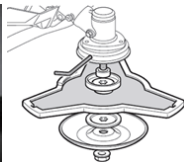

FIG.5-2

WARNING

Please make sure the cutting head has been

assembled correctly before use!

NYLON HEAD

RELEASE THE NUT

(FIG.6)

Line up the two holes of flange and shield, use one screw driver to hold the flange as below and turn the socket wrench clockwise, the nut will be released

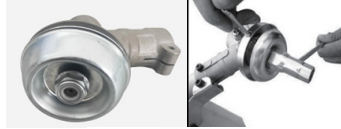

FIG.6

FIT THE NYLON CUTTING HEAD

(FIG.7)

Remove another shield after release the nut. Still hold the flange, take the Nylon cutting head on the shaft and rotate counter-clockwise, the Nylon cutting head is fitted.



FIG.7

RELEASE THE NYLON CUTTING HEAD

(FIG.8)

Remove another shield after release the nut. Still hold the flange, take the Nylon cutting head on the shaft and rotate counter-clockwise, the Nylon cutting head is fitted.



FIG.8

REPLACING LINE

1. Unclip the housing from the line trimmer and remove spool from the spindle.
2. Remove all remaining cutting line from the spool.
3. Cut 2m of line. Fold in half and attach the middle of the line into the groove/slot located in the center of the spool.



4. Wind both sides of the line on to the spool with tension in the same direction as shown on the inside of the spool. (See above right image)
5. Continue to wind the line until you have 150mm of line left on each end. Note: It is helpful to clip and fasten the line on opposite ends of the spool to keep the line from unraveling during the next step.



6. Put the spool into housing. Unclip the line from the spool and place line through the open eyelet on opposite ends of the housing. Ensure the line has not tangled.

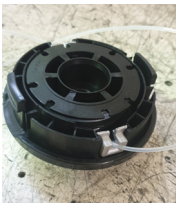

7. Clip the housing back onto the line trimmer



FEATURES & TECHNICAL DATA

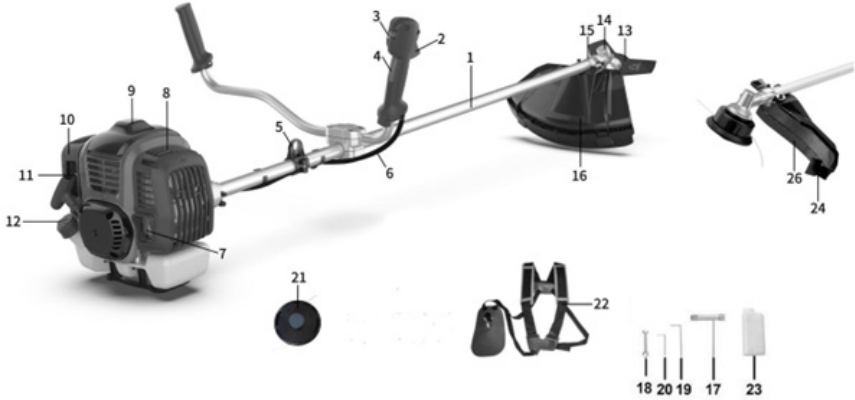

- | | | |
|-----------------------------|------------------------------|----------------------------|
| 1. Tube | 10. Air Filter Cover | 19. Allen Keys S b |
| 2. Throttle Trigger | 11. Choke Lever | 20. Allen Keys S 4 |
| 3. Engine Switch | 12. Fuel Tank Cap | 21. Trimmer Head |
| 4. Throttle Trigger Lockout | 13. 3T Blade | 22. Harness |
| 5. Suspension Point | 14. Gearbox | 23. Fuel Mixture Container |
| 6. Cable | 15. Guard Fixture | 24. Line Cutter |
| 7. Muffler Cover | 16. Cutting Attachment Guard | 25. Additional Guard |
| 8. Cylinder Cover | 17. Socket Wrench | |
| 9. Spark Plug Cover | 18. Spanner | |

MODEL	LMBC451
Idle speed (r/min)	2500 +/- 500
Nylon Head	Twin Line Tap & Go Head
Engine	Air-Cooling, 2 Stroke
Spark Plug	NGK BPMR7A / BOSCH WSR6F
Displacement (cc)	44.8
Maximum Cutting Speed	10000 +/- 500
Maximum Cutting Diameter	430mm
Maximum Output (kw)	1.6
Ignition	Electronic
Spool For Grass Trimmer	2.7 Diameter Line x 2m Length
Method of Starting	Soft Start Recoil
Fuel Used	Gasoline mixed with 2 stroke oil 25:1
Fuel Tank Capacity	920ml
Weight	9kg

Technical Data is subject to change without notice.

OPERATION

1. FUEL & OIL MIXTURE

Never use oil for 4-cycle engine use or water-cooled 2-cycle engine. It can cause spark plug fouling exhaust port blocking or piston ring sticking. Mixed fuels, which have been left unused for a period of one month or more may clog the carburetor or result in the engine failing to operate properly. Put remaining fuel into an airtight container and keep it in the dark and cool room.

WARNING

The brush cutter is fitted with a two-stroke engine; use fuel mixed with oil only.

DANGER

Fuel is explosive. Turn off and cool the motor down before filling the tank with fuel. You must observe all safety instructions relating to handling fuel.

Fuel used for this model is a mixture of unleaded gasoline and approved engine lubricant. When mixing petrol with two-cycle engine oil, use only petrol that DOES NOT contain ETHANOL or METHANOL (types of alcohols).

Use 91 unleaded petrol to fuel the unit. This will help avoid possible damage to the engine fuel lines and other engine parts.

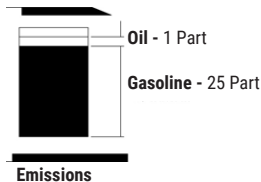

FUEL

The engine uses two-stroke fuel. If you have emission requirements, the mixture ratio of the fuel to oil should be 25:1

Be careful, a wrong mixture of the fuel will cause machine failure.

Petrol	2-Stroke Oil
1 Litre	25 ml
2 Litre	50 ml
5 Litre	125 ml

PETROL

Use 91 and above unleaded fuel.

We recommend unleaded petrol as it leaves fewer residues inside the motor and on the ignition plug, and prolongs the life cycle of the exhaust system. Never use old or dirty petrol or oil/petrol mixtures

STORING FUEL

The tank to store the fuel should be clean, anti-static, high-temperature-resistant, fire prevention and safe.

IMPORTANT

Two-stroke fuel may separate. Shake fuel container thoroughly before every use. Do not mix more fuel than you expect to use within a month. Take care of the emission of exhaust gases. Always shut off engine before fueling. Never add fuel to a machine with a running or hot engine. Never smoke whilst refueling and avoid inhaling the petrol fumes. Carefully open the tank top as pressure could have formed inside.

BEFORE REFUELING

- Shake the fuel mixture container well.
- Make sure the machine is turned off, by turn the engine switch to the "off" position.
- Check the fuel by a visual check, remove the fuel cap and review the fuel level.
- Fill unleaded fuel / oil mix from an approved fuel container into the fuel tank, because of fuel expands, please fill the tank to the neck of tank only.
- Turn the fuel cap clockwise to assemble it in position.

DRAINING FUEL

- Hold a collection container beneath the fuel drain bolt.
- Unscrew the fuel cap and remove it.
- Allow the fuel to run out completely
- Screw the fuel cap on firmly by hand.

FUEL MIXTURE CONTAINER

- Place the fuel mixture container on even and steady surface.
- First fill the gasoline to the scale marked gas "500".
- Then fill the 2-stroke engine oil until the scale marked oil "25:1".
- Shake the container gently, and then fill into the fuel tank.

2. RULES FOR SAFE OPERATION

WARNING

Read the "Rules for Safe Operation" with care and follow the instructions in the manual to operate the unit safely.

Read and be thorough with the basic controls and functions of the unit. It is important that you know how to stop and to shut off the engine, and to unhook a harnessed unit quickly.

Do not allow anyone without proper instruction or training to operate the unit. All operators of the unit should wear appropriate foot, leg, eye, face and hearing protection. Do not rely on the debris shield on the unit to protect your eyes from thrown objects.

Keep the area clear of bystanders, children and pets. Never allow children to operate or play with the unit. Do not allow anyone to enter the operating DANGER ZONE with you. The danger zone is an area 15 meters in radius (about 16 paces) or 50 feet.



Insist that persons in the RISK ZONE beyond the danger zone wear eye protection from thrown objects. If the unit must be used where there are unprotected people, operate at a low throttle speed to reduce the risk of thrown objects.

Move the stop switch to "stop" position when the engine idles, insure it reliable before cutting. Only may continue to operate the unit when stop switch is in good condition.

Routines for checking that the cutting attachment stops turning when the engine idles.

WARNING

In addition to head, eye, face and ear protection, please wear appropriate footwear to protect your feet and to improve footing on slippery surfaces. Do not wear open-toed footwear, or go bare foot or barefeet.

3. PREPARING FOR OPERATION

IMPORTANT

Failure to follow proper fuel mix instructions may cause damage to the engine.

When preparing fuel mixture, mix only the amount needed for the job you intend to do. Do not use fuel that has been stored longer than two months. Fuel mixture stored longer than this will cause hard starting and poor performance. If fuel mix has been stored longer than this time, it should be removed and filled with a fresh mixture.

WARNING

- Never fill the fuel tank to the brim. (Under 3/4 of the tank)
- Never add fuel to the tank in a closed non-ventilated area.
- Do not add fuel to this unit close to an open fire or sparks.
- Be sure to wipe spilled fuel before attempting to start the engine
- Do not attempt to refuel a hot engine.

CHECK POINTS BEFORE OPERATION

- Check for loose bolts, nuts and fittings.
- Check the air filter for dirt. Clean before operation.
- Check to be sure that protector is securely in place.
- Check that fuel isnt leaking.

STARTING THE BRUSH CUTTER

STARTING THE ENGINE

WARNING

The cutting attachment may start to move when the engine is started. Make sure the attachment can not come into contact with any object.

Make sure that no unauthorised persons are in the working area, otherwise there is a risk of serious personal injury.

1. Press the fuel pump several times until it fills with fuel. (Fig.12)

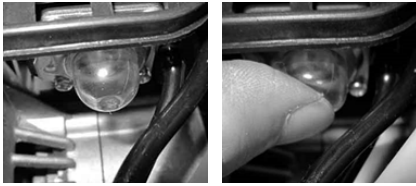

FIG.12

2. Turn the engine switch to the "I" position. (Fig.13) Press the throttle trigger, throttle trigger lockout and lock pin together to lock the trigger .

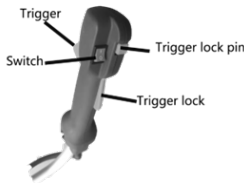



FIG.13

WARNING

the switch is auto-returned switch, it would always stays in "I" position, press it to "O" manually if needed.

3. In Res.13, Press the trigger lock to activate the trigger, then press the trigger lock pin together to make the trigger half open. This is for easier starting.
4. Move the choke lever to  position. (Fig.14)

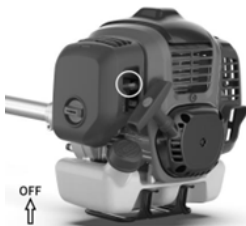

FIG.14

5. Close the choke: Start Position 



FIG.15

WARNING

Ensure the cutting attachment stops when the engine is idling. Note that initial engine startup may require multiple attempts for the fuel to reach the motor.

6. Turn the choke lever to the run position. (Fig.16)



FIG.16

7. Pull the starter quickly until the engine starts.
8. Press the trigger (in Res.13) to release the trigger lock pin.
9. After starting, let the engine run for 2 to 3 minutes before subjecting it to any load.

HOT START

When the machine is hot, keep the choke level in "Start position", the user can start the machine by repeating steps of 1,2,6,7.

WARNING

Under the following conditions the machine MUST be stopped.

- When the motor rotary speed changes
- When sparks occur
- When blades are damaged
- In case of misfire
- In case of high vibration
- When flames or smoke appear
- In rain or stormy weather

Check the cutting attachment always stops when the engine is idling.

FITTING THE FULL VEST HARNESS

(FIG.17)

Fit the harness well. Stretch the harness as below pic, and then fit on shoulder.

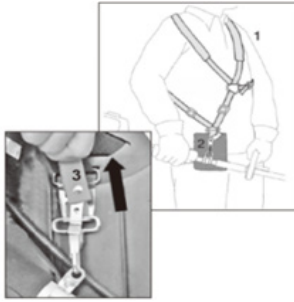

FIG.17.1

The design and type of carry strap may vary.

1. Place the full vest harness over your shoulders and clip in the middle.
2. Adjust to suit as so the harness is comfortable to wear.
3. Clip the BC451 on to the harness
4. Adjust the full vest harness if required to balance the BC451 on the harness.

WARNING

This carry strap has a safety device allowing you to immediately disconnect the strap from the machine in an emergency. To do so, pull forcefully on the red pull tab (3) on the strap. This disconnects the strap from the holding fixture immediately. NOTE: Never start the motor with the carry strap attached to the machine!

CUTTING WITH THE BRUSH CUTTER

Avoid operating the cutting tool at a speed just above clutch engagement to prevent premature clutch wear. Additionally, it is not recommended to continuously run the engine at maximum speed after cutting, as this can shorten the engine's lifespan.

WARNING

In an emergency, stop the engine by moving the engine switch to the stop position.

After the cutting attachment hits stone or debris, stop the engine and inspect for any damage or loose attachment. If the cutting attachment retains wet grass or branches, stop the engine and remove them.

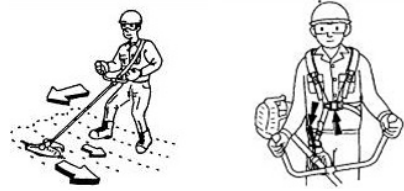

FIG.18

CUTTING ATTACHMENTS

Only use original cutting devices from the manufacturer



FIG.19

WARNING

The user assumes responsibility for any damages resulting from the selection, application, and usage of the accessory. When unsure or lacking knowledge about specific accessories, it is advised to contact your LawnMaster Sercie Dealer.

KICKBACK

Kickback occurs when a rotating blade is pinched or snagged, causing the power tool to forcefully move in the opposite direction of the blade's rotation at the binding point. The blade can jump towards or away from the operator, depending on its movement during pinching.

Kickback is the result of power tool misuse and/or incorrect operating procedures or conditions and can be avoided by taking proper precautions as given below.

- Maintain a firm grip on the tool and position your body and arm to allow you to resist kick back forces.
- Never place your hand near the rotating accessory. Accessory may kick back over your hand.
- Exercise caution when working near corners, sharp edges, or during bouncing to prevent snagging the accessory. Snagging can lead to loss of control or kickback.

EXTENDING THE CUTTING LINE

WARNING

Avoid metal wire or wire encased in plastic in the cutting head to prevent injuries. To extend the line, run the motor at full speed and tap the cutting head on the ground. This will automatically lengthen the line, with the cord cutter trimming it to the proper length (Fig. 20).

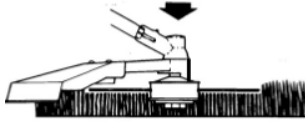

FIG.20

STOPPING THE ENGINE

1. Release the throttle trigger and let it run idling for a few minutes.
2. Switch off the engine by moving the engine switch to the stop position.

Ensure the cutting attachment has completely stopped turning before setting down the unit to prevent potential accidents.

MAINTENANCE & STORAGE

It is the operator's responsibility to complete all scheduled maintenance and or servicing in a timely manner. Always correct any issues before operating the brush cutter. Follow all inspection and maintenance recommendations that are listed in the manual.

WARNING

Improper maintenance and or failure to correct problems prior to operating the unit may cause the unit to malfunction and result in property damage and or serious personal injury. Improper maintenance and servicing may void warranty.

During maintenance operations:

- Remove the spark plug cap.
- Wait until the engine is sufficiently cold.
- Never dispose of oils, fuel or other polluting materials in unauthorized places.

Before performing any maintenance or cleaning work, always turn off the engine.

1. Do not spray the unit with water. Ingress of water may damage the engine and electrical connection.
2. Clean the unit with a cloth, hand brush, etc.

MAINTENANCE SCHEDULE

MAINTENANCE	DAILY MAINTENANCE	WEEKLY MAINTENANCE	MONTHLY MAINTENANCE
Clean the outside of the machine.	✓		
Make sure the throttle trigger lock and the throttle function correctly from a safety point of view.	✓		
Check that the engine switch works correctly.	✓		

MAINTENANCE	DAILY MAINTENANCE	WEEKLY MAINTENANCE	MONTHLY MAINTENANCE
Check that the blades do not move when the engine is idling or when the choke is in the start throttle position.	✓		
Check that the blades are undamaged and show no signs of cracking or other damage. Replace the blades if necessary.	✓		
Check that the blade guard is not damaged or distorted. Replace the blade guard if it is bent or damaged.	✓		
Clean the air filter. Replace if necessary.	✓		
Check that nuts and screws are tight.	✓		
Check that there are no fuel leaks from the engine, tank or fuel lines.	✓		
Check the starter and starter cord.		✓	
Clean the outside of the spark plug. Remove it and check the electrode gap. Adjust the gap to 0.6-0.7 mm or replace the spark plug. Check that the spark plug is fitted with a spark plug cap.		✓	
Clean the machine's cooling system.		✓	
Clean the outside of the carburetor and the space around it.		✓	
Check the flange, cap and nut are assembled correctly and tightened		✓	
Clean the fuel tank.			✓
Check all cables and connections.			✓
Check the clutch, clutch springs and the clutch drum for wear. Replace if necessary by an authorised LawnMaster Service Agent.			✓
Replace the spark plug. Check that the spark plug is fitted with a spark plug cap.			✓
To reduce the fire hazard, clean dirt, leaves and surplus lubricant, etc from the muffler and engine.			✓

MAINTENANCE Should be carried out at REGULAR INTERVALS in each of the indicated months or after a certain number of hours of operation (whichever comes first). (1)		BEFORE USE EVERY TIME	MONTHLY OR AFTER 25 HOURS	EVERY THREE MONTHS OR AFTER 50 HOURS	EVERY SIX MONTHS OR AFTER 100 HOURS
Air Filter	Clean			✓ (1)	
Fuel Tank & Filter	Clean				✓ (2)
Fuel Feed Line	Check (replace if necessary)	Every three years (2)			

(1) If operated in dusty areas carry out maintenance more frequently.

(2) A specialist technician should carry out this maintenance if the owner does not have the appropriate tools or mechanical knowledge.

AIR FILTER

(FIG.21)

WARNING

Cleaning the air filter is essential to guarantee the efficiency and duration of the machine. Do not work with a damaged filter or without a filter, as this could permanently damage the engine.

Clean the filter as follows:

- Loosen the knob (3), remove the cover (1) and the filter element (2).
- Wash the filter element (2) with soap water. Do not use petrol or other solvents.
- Leave the filter to dry in the open air.
- Fit the filter element (2) and the cover (1) back on, tightening the knob (3) again.
-

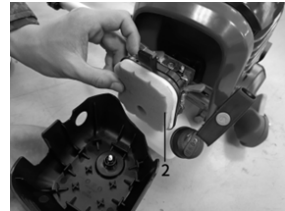
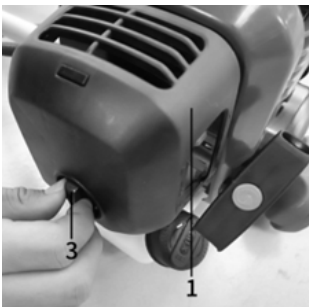

FIG.21

WARNING

The use of petrol or combustible solvents for cleaning can cause fire or explosion. Therefore only use soap water or non-combustible solvent. Never operate the machine without the air filter.

SPARK PLUG

RECOMMENDED SPARK PLUG: NGK BPMR7A / BOSCH WSR6F To ensure proper engine operation, the spark plug must be properly gapped and free of deposits.

1. Remove the spark plug cap.
2. Clean any dirt around the spark plug base.
3. Use the socket spanner which provided to remove the spark plug.
4. Visually inspect the spark plug. Remove carbon deposits using a wire brush.
5. Check for discoloration on the top of the spark plug. The standard color should be a tan color.
6. The acceptable spark plug gap should be between 0.6 - 0.7mm.

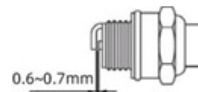

7. Install /reinstall the spark plug carefully by hand.
8. Once the spark plug has been seated, tighten it with a socket spanner.
9. Reinstall the spark plug cap on top of the spark plug

CLEANING

1. To keep your machine clean, use a damp cloth with mild detergent for the exterior—avoid water to prevent internal damage.
2. Some maintenance products and solvents may damage the plastic parts, these include products containing benzene, Trichloroethylene, chloride and ammonia.
3. Keep ventilation inlets/outlets clear. Use a soft brush and compressed air for internal cleanliness.
4. Wear eye protection when carrying out cleaning.

ANGLE TRANSMISSION

(FIG.22)

Lubricate with lithium-based grease. Remove the screw (1) and put in the grease, turning the shaft manually until grease emerges, then replace the screw (1).



FIG.22

STORAGE

At the end of each working session, carefully clean the machine of dust and debris, and make sure that there are no damaged parts, replacing any faulty parts. The machine must be stored in a dry place away from the elements and with the cover correctly fitted.

- Keep all nuts and screws tight to be sure the equipment is in safe working condition.
- Never store the equipment with petrol in the tank inside a building where fumes can reach an open flame or spark.
- Allow the engine to cool before storing in any enclosure.
- To reduce the fire hazard, keep the engine, silencer and petrol storage area free of vegetative material and excessive grease.
- Replace worn or damaged parts for safety.
- If the fuel tank has to be drained, this should be done outdoors.
- Always clean and maintain before storage.
- Never disassembly the guards for cutting attachments.
- Always store the metal blade in cool and dry place, never use rusted blade. It may cause serious injure during working.

Transporting the machine in a car, please empty the fuel tank completely first to avoid the leakage.

Store the machine, operating instructions and where necessary the accessories in the original packaging .In this way you will always have all the information and parts ready to hand.

Pack the device well or use the original packaging in order to avoid transit damage. Use protective gloves when handling the blades. Keep the blade protection device on, except when intervening directly on the blade.

Store the machine in dry and well ventilated surroundings and with the fuel tank empty. Do not store fuel next to the machine.

TROUBLESHOOTING

PROBLEM	CHECK	CONDITION	CAUSE	SOLUTION
The engine stalls, is difficult to start or doesn't start	Fuel at the carburetor	The fuel does not arrive at the carburetor	Fuel filter blocked	Clean or replace
			Fuel supply blocked	Clean or replace
			Carburetor	Ask your LM dealer for advice
		Fuel at the cylinder	There is fuel in the exhaust	The fuel mixture is too rich
	Clean or replace the air filter			
	Ask your LM dealer for advice			
	Sparks at the spark plug electrodes	There is no spark	Switch in "0" position	Set the switch to the ON position (Run)
			Electrical problem	Ask your LM dealer for advice
			Locked switch	
	Sparks at the spark plug	There is no spark	Bad spacing of the electrodes	Adjust the gap to 0.6-0.7 mm
			Electrodes contaminated	Clean or replace
			Electrodes contaminated with fuel	Clean or replace
			Defective spark plug	Replace the spark plug
	The engine turns, but stalls or does not accelerate correctly	Air filter	Dirty air filter	Fair wear and tear
Fuel filter		Dirty fuel filter	Dirt or residue in the fuel	Replace
Spark plug		Dirt or worn spark plug	Fair wear and tear	Clean, adjust or replace
The engine does not engage	N/A	N/A	Internal engine problem	Ask your LM dealer for advice

WARRANTY

Subject to the following conditions, this unit is covered by a comprehensive two-year warranty.

The unit is designed for domestic purposes only, issues and faults due to commercial use may not be covered by warranty. The warranty covers all manufacturing faults but excludes normal wear and tear, misuse, neglect, accidental damage or defects arising from failure to comply with instructions as outlined in this owners manual. Only genuine spare parts can be used for repairs and this must be carried out by an authorised LawnMaster Services Dealer to maintain warranty.

Warranty does not cover the cost of transportation of any part(s) but does cover the labour/parts cost incurred in repairing or replacing any defective part(s) consequential or special damages and / or expenses resulting from any defect.

If the unit requires further repairs or services please visit www.lawnmaster.co.nz to find your local LawnMaster Service Dealer.

For all other enquiries contact **Steeffort Customer Services +64 6 350 1350**

LawnMaster®

FIND US



www.lawnmaster.co.nz



lawnmasternz

Steelfort

500 Rangitikei Street, Private Bag 11045
Palmerston North, 4412, New Zealand
06 350 1350

Steelfort Auckland

880 Great South Road, Penrose
Auckland, 1061, New Zealand
09 573 1324